

D. Installation

1. Storage and Shipping	72
2. Installation and Connection	74

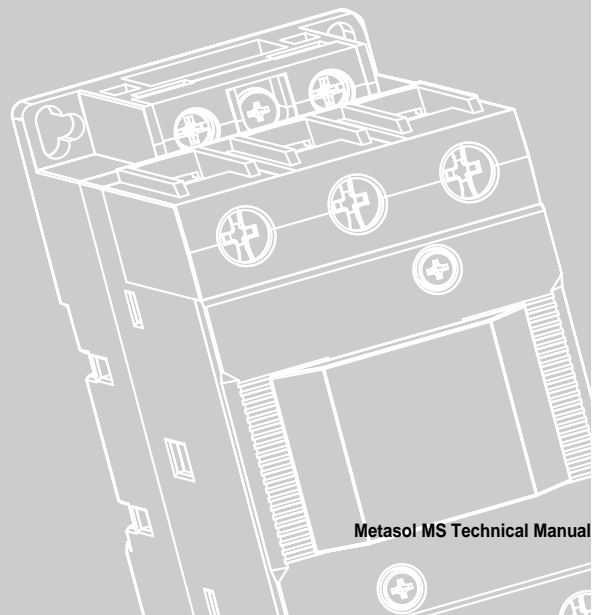

Installation

1. Storage and Shipping



- Please do not damage the product by packing material (paper, wood, nails), edge of product from dropping it.
- Confirm whether it has a missing or damaged part by accident during shipping.
- Don't place it in a humid or dusty environment after opening.
- Do not put anything on the product or step on it.

1.1 Precautions for Storage

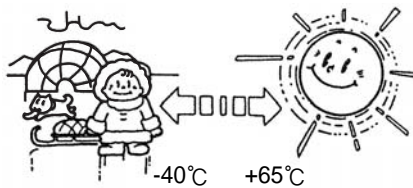

• Surrounding temperature

The surrounding temperature while storing or shipping is recommended to be within the range of -40°C ~ 65°C .

The operational temperature of the general operational range should be maintained.

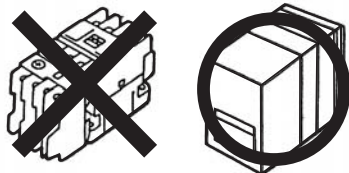

Individual product Packed product

• Storage under packed conditions

Do not store it individually after it's been removed from its original packaging in order to prevent damage, dust, corrosion, be sure store back in its original box.

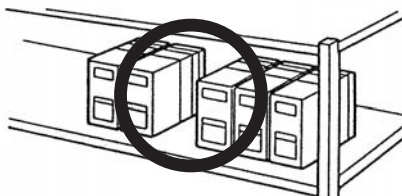

• Storage place

Storage place shouldn't be on the ground (ie. A concrete floor), please store the product on a pallet or shelf and avoid exposing it to direct sunlight.



• Avoid humidity

Do not place it in a humid place for a long time.

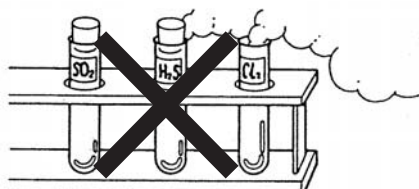

• Avoid corrosive gas

Do not place it in an atmosphere containing hydrogen sulfide gas, ammonia gas, chlorine gas etc.

1.2 Shipping Precautions



- **Careful packing and shipping warning**

Do not drop it while shipping.

Pack it carefully when shipping after wire distribution assembled at the panel.

- **Do not hold or grab the terminals or attached cables while shipping**

It can be damaged or dropped when carrying the product by holding product's terminals, TOR, latch device, cable etc. **Definitely carry it by holding the main body.**

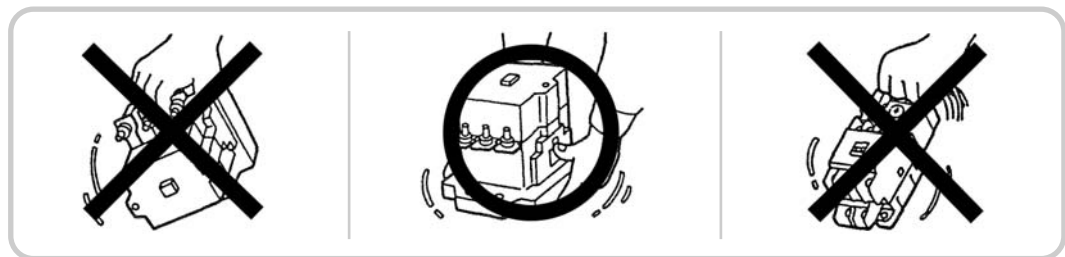

1.3 After Installation, Long-term Inaction Before Operational



It is not used sometimes with current flow for a long term period after completing panel (switchboard, control board). Especially when returning while construction, cement, concrete, moisture, etc. sometimes can penetrate inside.

In this case, please use temporary protection treatment (anti-vibration, waterproofing) until reaching normal driving conditions.

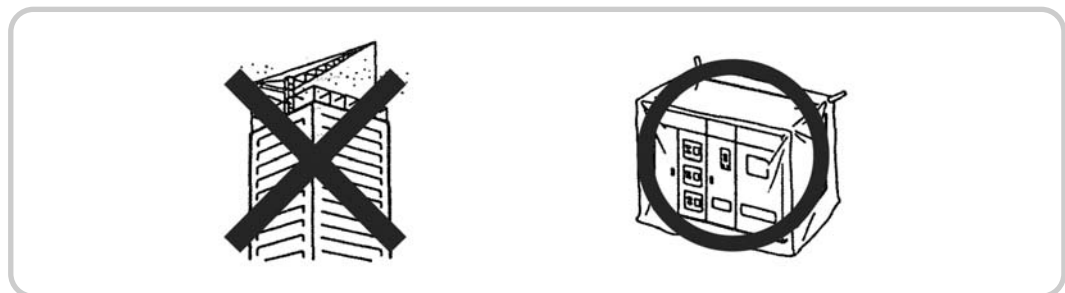

1.4 Packing When Exporting

Normally, the magnetic switch is often exported as a single product or assembly by ship, and often placed for a long time in harbor warehouses. And preventative measures must be considered for the natural environment of salinity and heat while shipping, because it is sometimes passed through equatorial regions in the storage on the ship. The environment influencing exported product passing through tropical areas is high temperature, high humidity, the most influencing thing to the magnetic switch is humidity. Because humidity can be a cause of product rust or mildew, the exported product needs to be treated against this.

Because of this, putting more than 3kg per 1m² of moisture absorbant (silica gel) is recommended for decreasing humidity when packing for export.

2. Installation and Connection



Please stay away from and do not touch this product while current is flowing.
There is a danger of electrocution and burns.



- **Please be careful not to let abnormal material penetrate inside the product during installation distributing wire.**
- **Do not use product damaged by a big shock during shipping/installation**
- There is a danger of dropping when changing the size of installing bolt or shortage of bolts or an unstable attachment to DIN rail.
- **Do not use the damaged product** because there is a danger of overheating, electric short when it is damaged during installation of distributing wire.
- It can not be opened even when control voltage is off because of a loosened wire.
- **Do not manually operate under a live wire condition(when power is on).**
- **Please use the assembled product with closing cover while current is flowing due to danger of electrocution.**
- **Do not attach in the opposite direction of normal attachment (up and down), horizontal floor attachment, ceiling attachment.**

2.1 Operational Place and Installation Angle

1) Environment

- Please install in a place where it is dry, without dust, without corrosive gas or vibration.
- You need to consider protective structure of the case coverin the place where the surrounding conditions are bad such as dusty or much corrosive gas.

2) Installation angle

- Please tighten the terminal screw, with the corresponding assembly torque, corresponding to the terminal screw size, by Item 5 on page 79 “Applicable wires or assembly torque”.
- Regular attachments follows a vertical plane, but it is possible for the attachment angle to be skewed by up to 30° in any direction (back, forth, left or right).

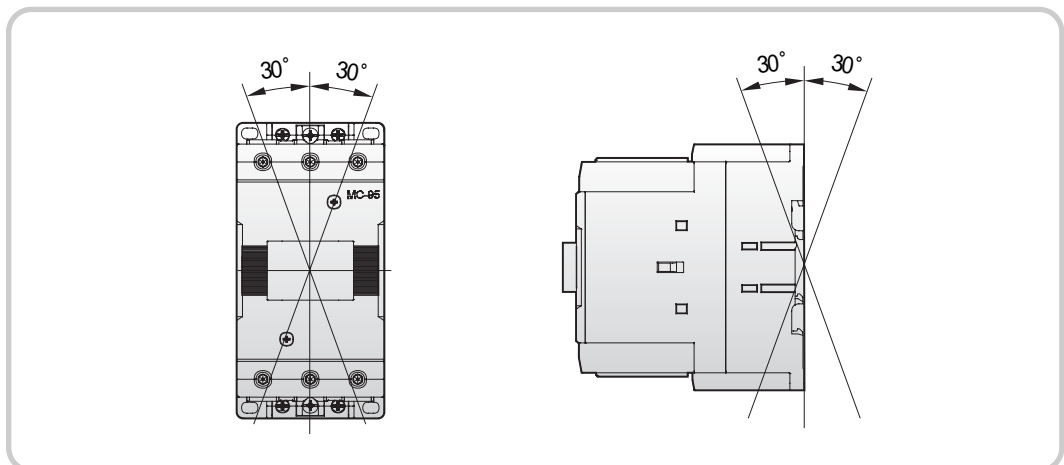

Fig. 12. Tollerable limit of vertical olane

- When lateral installation is needed in wire distribution or installation relation, use the following precautions:
 - Please install with being rotated 90 degrees counterclockwise from standard installation direction as seen in figure 13. If you' re only using the magnetic contactor, any direction is okay.

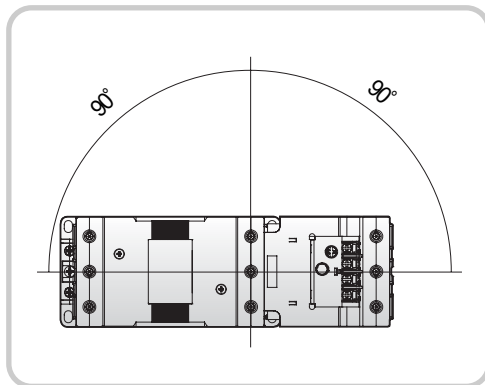

Fig. 13. Lateral installation

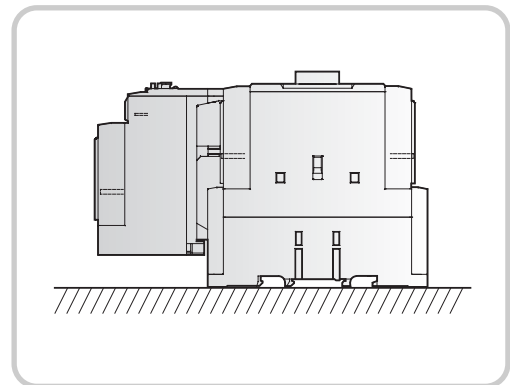

Fig. 14. Horizontal installation

- There is no difference with the characteristic of the magnetic contactor when lateral installation, mechanical on/off durability or on/off frequency can be decreased.
- Action limit current of the Thermal Overload Relay is slightly changed.
- Lateral installation is not allowed for a DIN rail installation.**

Table 2. Assembly state and mechanical life span

Type	Opening/closing frequency (more than times/hours)		Type	Opening/closing frequency (more than times/hours)	
	Standard installation	Lateral installation		Standard installation	Lateral installation
MC-6a~18a	1,800	80% of standard installation	MC-130a, 150a	1,200	80% of standard installation
MC-9b~22b	1,800		MC-185a, 225a	1,200	Lateral routing structure is impossible
MC-32a, 40a	1,800		MC-265a~400a	1,200	
MC-50a, 65a	1,800		MC-500a~800a	1,200	
MC-75a~100a	1,200				

2. Installation and Connection

2.2 DIN Rail Attachment

1) Installation pitch of terminal screw for rail fixture

Rail fixture is recommended to be installed under rail fixture terminal screw pitch from table 3 when it is installed on a 35mm width support rail.

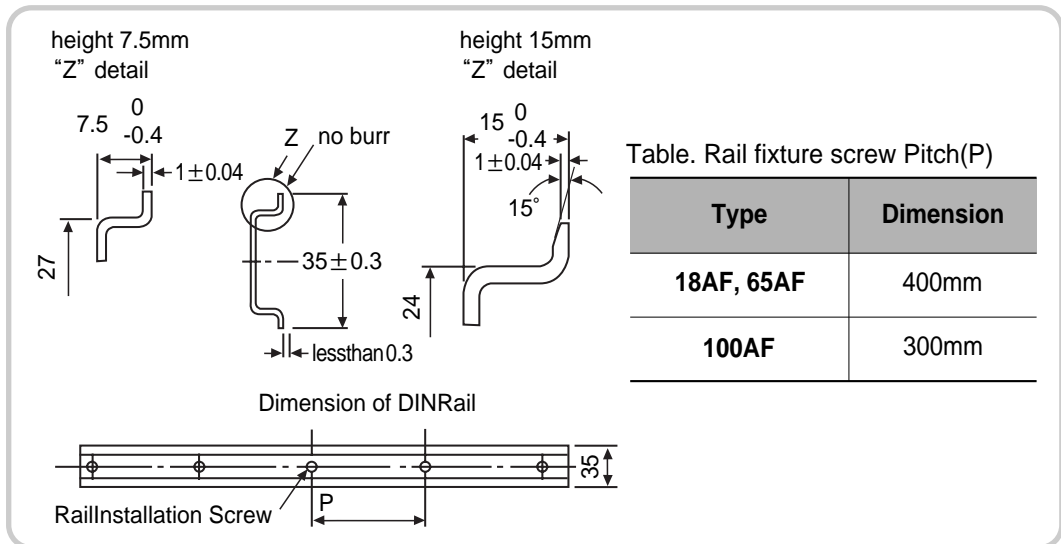

2) Product arrangement on rail

The product interval on a rail needs to be installed more than standard level from table 4. Please use and make sure the minimum interval of magnetic contactor is more than the level from table 4 in order to acquire the insulation distance or heat radiation in the case of close installation of same types of magnetic contactor.

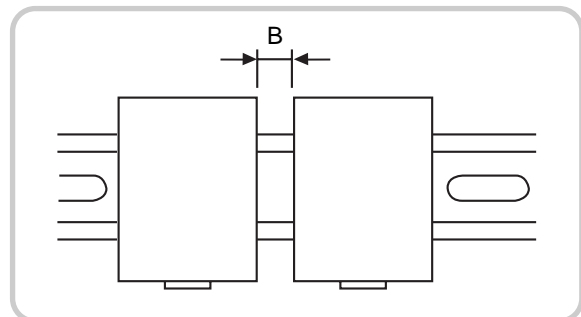

Fig. 15. Interval of product arrangement

3) Rail attachment / detachment

Types	Attachment method	Detachment method
Figure		<p>aCase of the MC-100a</p>
Method	<p>Push in the direction of the arrow by hanging the hook part on the rail.</p>	<ul style="list-style-type: none"> In the case of MC-18a, 40a, 65a lift up the bottom when the product is set down. In case of MC-100a move in the direction of the arrow by putting the driver on the main body slide part.

2.3 Installation Minimum Distance Intervals



Magnetic switch Metasol MS is the structure not emitting an arc at the opening of the arc extinguish chamber when breaking the load current, please maintain the interval as seen in the table below otherwise it can cause not only a serious accident but also be dangerous if there are other devices or metal parts around.

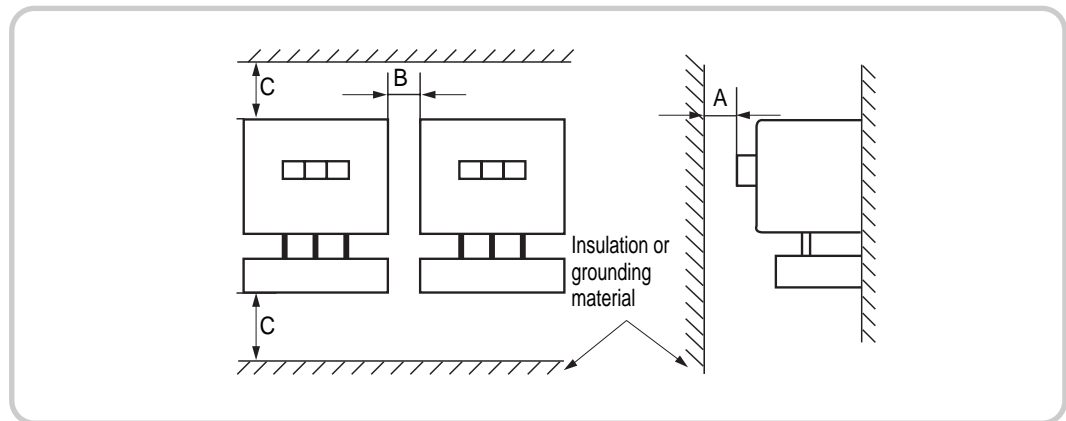

Table 4. Installation minimum interval dimensions

(unit: mm)

Model		A	B	C	Reference
Contactor	Switch				
MC-6a ~ 18a	MS-6a ~ 18a	10	2	15	
MC-9b ~ 22b	MS-9b ~ 22b	10	2	15	
MC-32a ~ 65a	MS-32a ~ 65a	10	4	15	
MC-75a ~ 100a	MS-75a ~ 100a	10	6	25	
MC-130a, 150a	MS-130a, 150a	20	10	30	
MC-185a, 225a	MS-185a, 150a	30	10	50	
MC-265a ~ 400a	MS-265a ~ 400a	50	10	50	
MC-500a ~ 800a	MS-500a ~ 800a	50	10	80	

- **Close attachment is not recommended when installation magnetic switch or magnetic contactor continuously.**
Durability of coil can be reduced by temperature rise depending on operational conditions (continuous current flow operational or close attachment of high on/off frequency product series)
- Characteristic of TOR is changed by the mutual heat influence. Maintaining product mutual interval more than the interval from table 4 is recommended in this situation.
- **A dimension is arc space dimension when safety cover is used.**

2. Installation and Connection

2.4 Terminal Assembly Method



- There is a danger of overheating, fire when terminal assembly is loosened.
- Please assemble with the assembly torque which was specified by this company, tighten it periodically.
- Terminal screw can be damaged when assembly torque is excessive.
- There is a danger of short circuit when compressed terminal, connected conductor (connected to terminal) don't have enough insulation distance.
- There is a danger of overheating, fire when the wire size is not large enough.
- Please use the wire under proper operational conditions.
- When Lock paint etc. is applied to wire contacts or contact points, there is a danger of overheating, fire by fault.
- **Please tighten it completely with the specified assembly torque when the terminal screw is loose. There is a danger of overheating and fire.**

1) Voltage, frequency of coil

The voltage and frequency of the control circuit, and rated indicating voltage of coil and frequency need to be aligned.

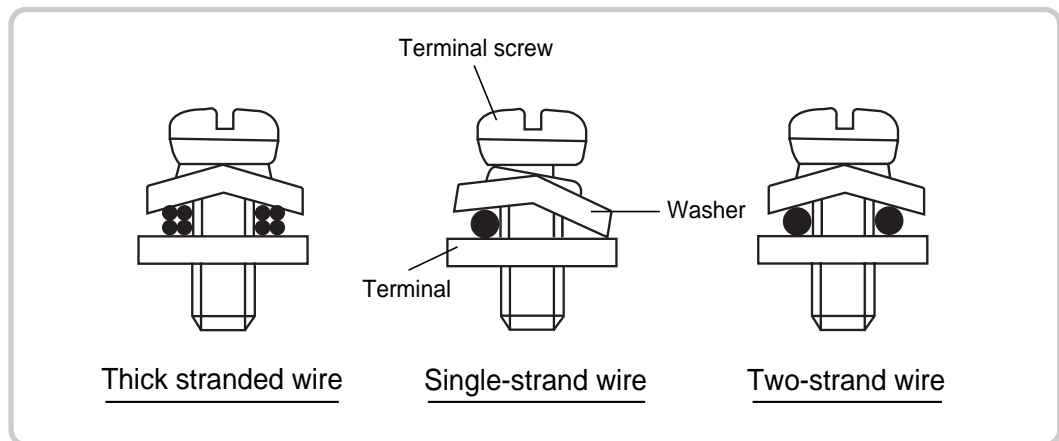

2) Self-up terminal screw connection

Connect the compressed terminal as it is, and take off the insulation coating of the wire and then use it. In case of thick stranded wire, divide the strands in two then connect them.





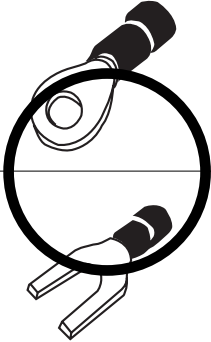
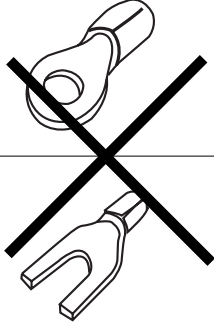

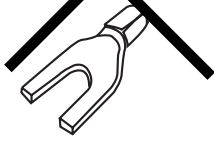











3) It is applied to the circuit 380V

Using insulation tube type compressed terminal is recommended because the insulation distance is not enough due to the inclination of the compressed terminal during wire distribution when magnetic contactor, TOR is used at the compressed terminal connection to the circuit of more than 380V.

Type	Insulation tube type compressed terminal (PG terminal)	Compressed terminal
O-Ring Compressed terminal		
Y Compressed terminal		

4) Wire and torque apply

Frame	Wire type							Torque
		(mm ² /AWG)						[Nm][lb-in]
MC-18AF		1~6/18~10	1~6/18~10	1~6/18~10	1~6/18~10	1~10/18~8	up to 1.13/10	
MC-22AF		1~6/18~10	1~6/18~10	1~6/18~10	1~6/18~10	1~10/18~8	up to 2.25/20	
MC-40AF		1~6/18~10	2.5~10/14~8	2.5~10/14~8	2.5~10/14~8	1~10/18~8	up to 4/35	
MC-65AF		-	-	-	-	1~25/12~4	up to 4/35	
MC-100AF		-	-	-	-	1~25/12~4	up to 4/35	
MC-150AF		-	-	-	-	1~25/12~4	up to 9.8/87	
Coil terminal		0.5~2.5/20~14	0.75~25/18~12			0.5~25/20~12	up to 2.25/20	
MC-225AF		-	-	-	-	2.5~150/8~300	up to 14.7/130	
MC-400AF		-	-	-	-	2.5~200/8~700	up to 22.6/200	
MC-800AF		-	-	-	-	80~325/ 2/0~Busbar	up to 26.5/500	
Coil terminal		1.25~5.5/16~10	1.25~5.5/16~10			1.25~5.5/16~10	up to 1.75/15	

Installation

2. Installation and Connection

2.4 Terminal Assembly Method

5) General assembly torque

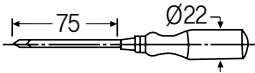
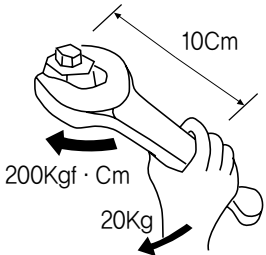
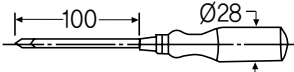
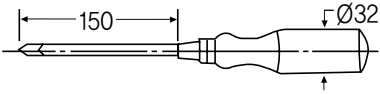
Type	Driver maximum tightening torque (kgf · cm)			Wrench tightening torque (kgf · cm)	
	Screw driver	Both	Right		Left
Form		28	22	20	
		40	35	33	
		58	43	42	
Tightening torque standard	<ul style="list-style-type: none"> Rotate with assembly direction with holding driver horizontally The grip of a man is 50Kg(500N) with the right hand, and 45Kg(450N) with the left hand. 			<ul style="list-style-type: none"> Because the standard muscle of man is about 20Kgf, it becomes 200Kgf·cm of torque when the screw driver length is 10cm 	

6) Burnout by terminal connection fault

When distributing wires at the terminal part, they can finally burn out from overheating by lack of tightening torque or forgetting an assembly screw. **Therefore examine thoroughly when distributing.**

7) Please ground outer housing when case cover is metal in case of assembled type switch.